

## SEALED POSTER SHOWBOARD



## OUTDOOR LOCKABLE SHOWCASES FOR DISPLAYING INDIVIDUAL POSTERS

High quality Sealed Showboard is offered in a range of sizes and features. It is equipped with black gasket which helps to keep out moisture. Locks prevent vandals from tampering with messages.

### KEY SELECTION ATTRIBUTES

- \* OUTDOOR FRIENDLY, sealed and lockable showboards for displaying individual posters and single sheet menus in 20"x30", 22"x28", 30"x40", 36"x48", 40"x60" sizes.
- \*Max. available size 40"x60".
- \* Perfect way to offer multiple services, present/change messages, announcements and promotions in outdoor places under a shelter or public buildings like offices, hospitals, schools, restaurants and more.
- \* Suitable for wall mounting in portrait or landscape positions.
- \* One set includes 1.96" natural silver anodised aluminium frame with 1.33" depth and locking; (PP) propopylen backing; clear plastic pegs to hold and change the posters easily; vandal resistant protective PET-G glazing cover; 2 stays at each end to keep the cover door open; 2 set of keys; 4 screws and 4 anchors for installing on wall.

- \* Suitable for weatherproof use by rubber gasket isolation inside the frame.
- \* Lockable cover can be opened to 90 degrees. 2 stays keep the door open for practical poster change.
- \* Optional V-Hangers for easy mounting.
- \* Each unit is strongly packed in a single box with mounting set and easy-to-understand installation sheet.
- \* Natural silver-anodized in standard and various RAL colors available with antimicrobial powder coating.



## COLOURS IN STOCK



Silver

## SUITABLE FOR

Sealed Showboard Posters can be used for INDOOR and OUTDOOR applications, for signage needs in many locations like shopping centers, markets, groceries, hotels, offices airports, shops and stores, hospitals, schools, apartments, museums, restaurants, theatres, commercial advertising and even art works and many more.

## FEATURES



## EXPLODED VIEW



## TECHNICAL DRAWING

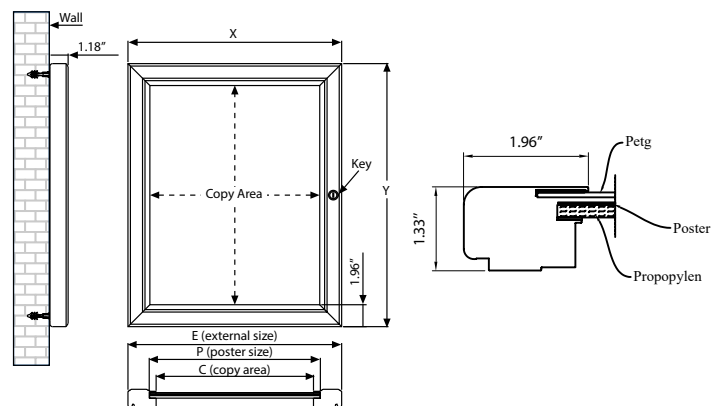

## PHYSICAL DATA

### Material

1.96" aluminum profiles with 1.33" depth. Vandal resistant protective PET-G poster cover, (PP) propopylen backing. Rubber Sealing.

### Surface Finish

Silver anodized in standard. Custom colors also available with antimicrobial powder coating, call for custom color requests. PET-G glazing protective cover in standard.

### Recycled Content

Up to 78% recycled content used.

### Warranty

All products are guaranteed for 2 years by MT Displays with below conditions: [Warranty Conditions](#)

### Storage Conditions

Goods should be stored at 32°F to 77°F in a dry place. Store in the original package.

### Installation Considerations

Sealed Poster Showboards are strongly packed in a single box with mounting set and easy-to-understand installation sheet. One set includes 1.96" natural silver anodised aluminium frame with 1.33" depth and locking; (PP) propopylen backing; clear plastic pegs to hold and change the posters easily; vandal resistant protective PET-G glazing cover; 2 stays at each end to keep the cover door open; 2 set of keys; 4 screws and 4 anchors for installing on wall. Optional V-Hangers for easy mounting. Lockable cover can be opened to 90 degrees. 2 stays keep the door open for practical poster change. Please discard the protective film on the unit before use.

### Design Considerations

OUTDOOR FRIENDLY, sealed and lockable showboards for displaying individual posters and single sheet menus in 20"x30", 22"x28", 30"x40", 36"x48", 40"x60" sizes. Max. available size 40"x60". Perfect way to offer multiple services, present/change messages, announcements and promotions in outdoor places under a shelter or public buildings like offices, hospitals, schools, restaurants and more. Available for weatherproof use by inside water leakage isolation. Suitable for wall mounting in portrait or landscape positions. Suitable for weatherproof use by rubber gasket isolation inside the frame. Suitable for silk screen printing, max. letter height is 1.18". Please use the clear plastic pegs to hold the poster inside the frame.

### Cleaning and Disinfecting

Clean your displays, with damp microfiber clothes, rinsed with simply water or warm, soapy or gentle shampooed water. Avoid using vinegar, abrasive, acidic, alcohol-based or heavy cleaners or cleaners containing Ammonia. Only after cleaning the product, if needed, simply apply disinfectant or sanitizer that is in compliance with your local guidelines and regulations.

### Hazardous Substances

M&T Displays prioritizes compliance with the REACH (Registration, Evaluation, Authorisation and Restriction of Chemicals) and RoHS (Restriction of Hazardous Substances) directives to protect both the environment and human health. We ensure that our products do not contain substances listed under REACH and adhere to strict RoHS limits for hazardous materials. Our manufacturing process ensures that lead, mercury, cadmium, and other restricted substances remain within the permitted thresholds, guaranteeing safe and sustainable products for our customers.



T: +1 855-478-0652 / info@mtdisplaysllc.com / www.mtdisplaysllc.com

# PRINT TEMPLATES

## Sealed Poster Showboard - 22"x28"

Document Size: 22.4"x 28.4" (Includes Bleeds)

Finished Size: 22"x28" [Print](#)

## Sealed Poster Showboard - 30"x40"

Document Size: 30.4"x40.4" (Includes Bleeds)

Finished Size: 30"x40" [Print](#)

## Sealed Poster Showboard -40"x60"

Document Size: 40.4"x60.4" (Includes Bleeds)

Finished Size: 40"x60" [Print](#)

## Sealed Poster Showboard - 20"x30"

Document Size: 20.4"x30.4" (Includes Bleeds)

Finished Size: 20"x30" [Print](#)

## Sealed Poster Showboard -36"x48"

Document Size: 36.4"x48.4" (Includes Bleeds)

Finished Size: 36"x48" [Print](#)

# ARTICLES

ARTICLE	EXTERNAL (x-y)	POSTER	COPY	NUMBER OF KEYS	WEIGHT	PACKING SIZE
					WITH PACKING	*W X H X D
USBNS00022	24.96" x 30.98"	22" x 28"	21" x 27"	2	10,36 lbs	26,38" x 32,28" x 2,17"
USBNS00023	22.95" x 32.95"	20" x 30"	19" x 29"	2	10,36 lbs	24,21" x 34,25" x 2,17"
USBNS00034	32.95" x 42.95"	30" x 40"	29" x 39"	2	18,56 lbs	34,25" x 44,09" x 2,17"
USBNS00036	38.97" x 50.98"	36" x 48"	35" x 47"	2	24,14 lbs	40,35" x 52,36" x 2,17"
USBNS00046	42.95" x 62.95"	40" x 60"	39" x 59"	2	31,33 lbs	44,29" x 64,17" x 2,17"

# INSTALLATION INSTRUCTIONS

## Sealed Poster Showboard / 1001897

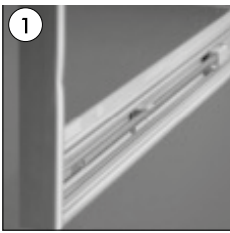

• Open the cover door.

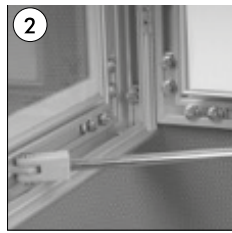

• Take out the metal bars from the slots inside the cover. Fix the cover in open position by leaning the ends of the metal bars to the plastic holder in the bottom and upper profiles of the frame.

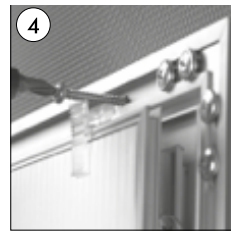
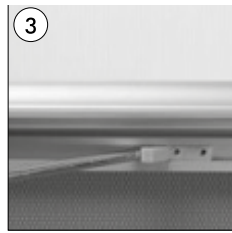

• Fix the frame to the wall through the holes in the canal.

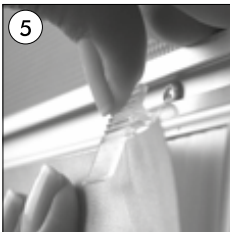

• Place in the poster via the plastic pegs.

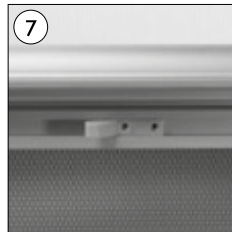
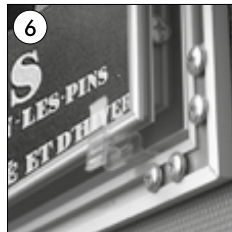

• Mount the metal bars to the slots, inside of the cover, after taking them out from the plastic holders. Lock the cover after closing.

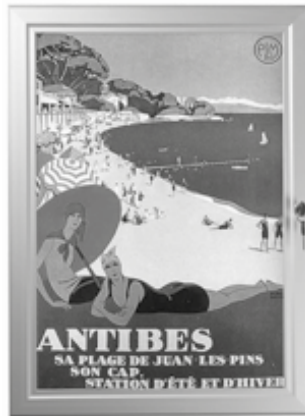
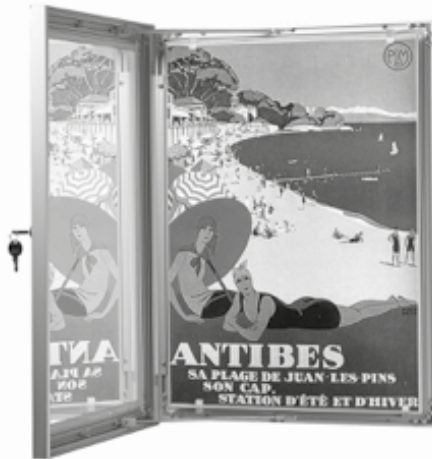
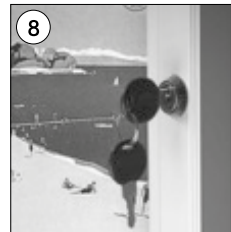

This technical sheet's contents are all subject to update and modification at MT Displays' exclusive discretion. There is nothing official about this document. For final and legally binding information, please get in touch with the sales staff at MT Displays.



T: +1 855-478-0652 / [info@mtdisplaysllc.com](mailto:info@mtdisplaysllc.com) / [www.mtdisplaysllc.com](http://www.mtdisplaysllc.com)